

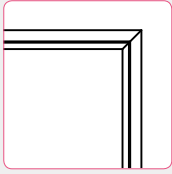





# Wall Hatch Stainless frame type

## WMS [WMS Stainless with Key]

 <b>Frame Type</b>	 <b>General Type</b>	 <b>Other</b> Way of outer frame mounting	 <b>Slide opening</b>
		 <b>With Key Type</b>	 <b>Customize dimension</b> 300×300~450×600mm

## Stainless frame type suited for tile finish

**With Lock Key / Hexagon socket head cap**  
Adapt the high crime prevention "Dimple key" suited for Plumbing inspection in the place where a crowded station premise and entrance in condominium etc are.



**Simple design**  
Only the Frame and Key cap stand out.

**Axis type**  
"Axial rotation mechanism" that doesn't use the hinge.

**Left or Right opening**  
Corresponds to the enforcement both of Left and Right opening.

**Frame type**  
Slim frame type whose total width is 11mm.

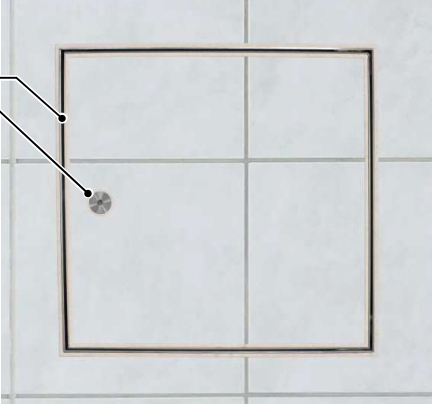
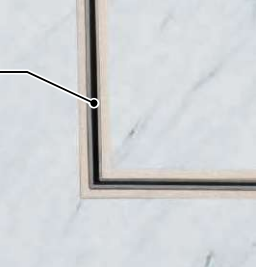
**Finishing**  
Corresponds to until 1kg tile finishing.

### Dimensioned diagram

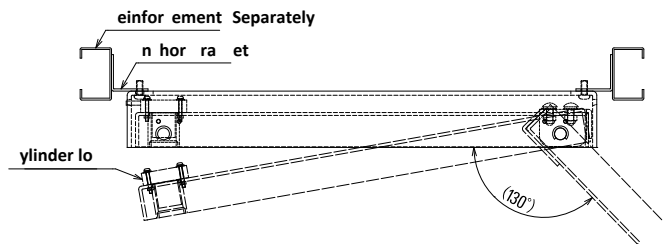
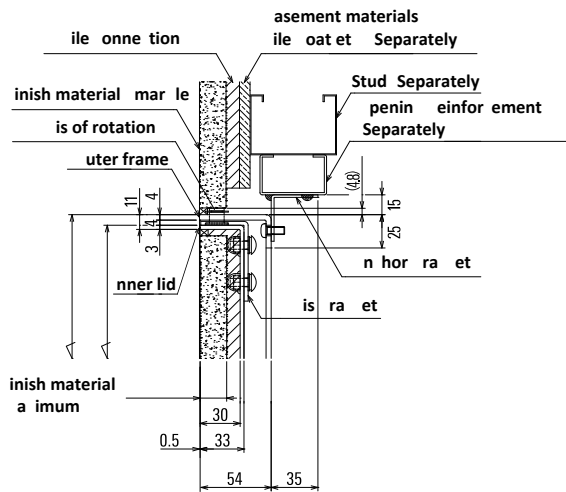

#### Parts specification

Parts	Materials	Finish
Inner lid / Outer frame	SUS304	No.4 (Frame part)
	SUS304 etc.	-
Open and Close guide bracket	SUS304	-
Cylinder lock	Stainless etc.	-
Lock cover	SUS304	-
Lock cap	SUS304	-
Anchor bracket	SUS304	-

- Inner lid finish materials range
- Inner lid finish materials range

Model	Series name	Outer frame outer dimension mm	Inner lid dimension mm	Frame	Material	Type per carton	Accessories		Remarks
							Inner lid	Outer frame	
WMS	30	300×300	284×283.5	WMS30	1	1	8	8	Made of stainless steel penin lid type with key outer frame inner frame type
	45	450×450	434×433.5	WMS45			8	8	